

BS-NOBLE Instructions

BS-NOB1565: 1A,1W,1U,1T

BS-NOB1665: 1Q,1S,1M

BS-NOB1765: 1G,1F

IMPORTANT. RETAIN FOR FUTURE REFERENCE.
READ CAREFULLY

30 min. ▶

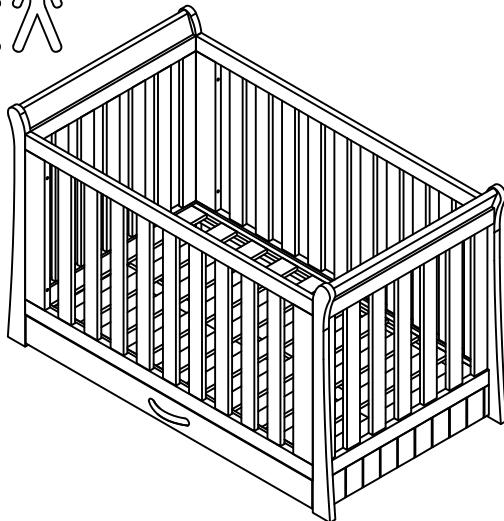
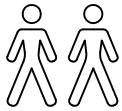

1S

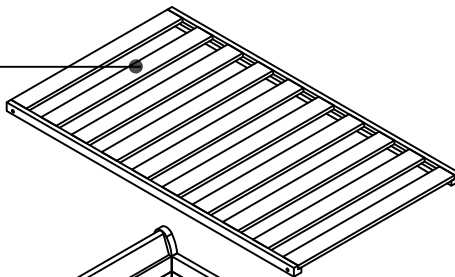

1A(x2)

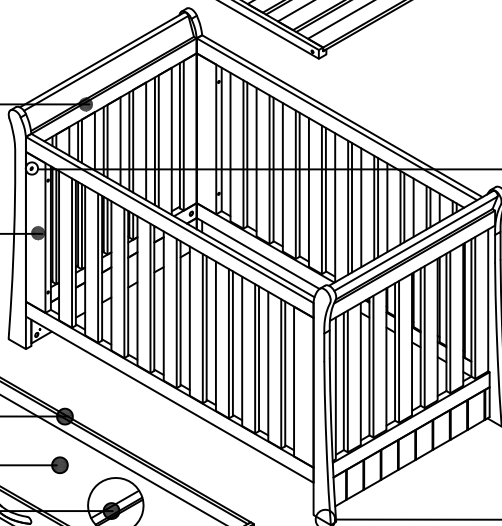

1Q(x2)

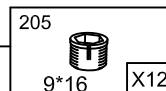

1F(L)

1F(A)

1M

1F(OX2)

1F(R)

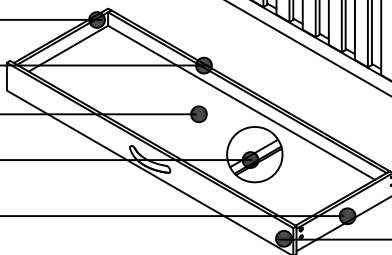

1G

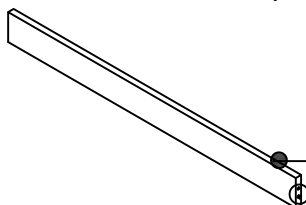
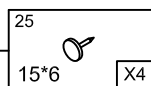

1T

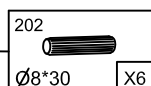

1U

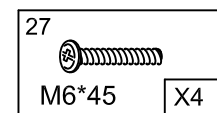
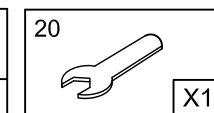
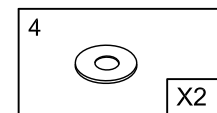
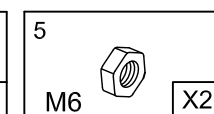
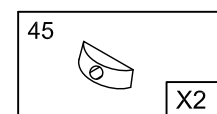
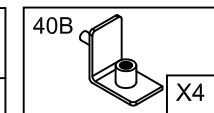
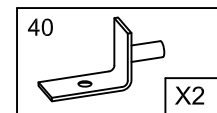
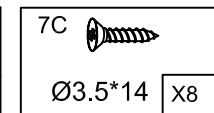
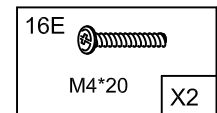
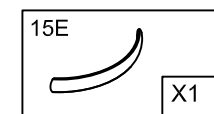
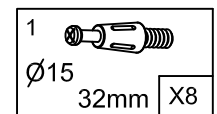
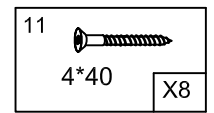
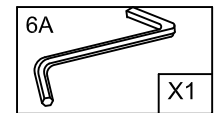
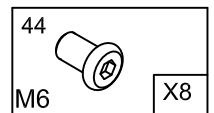
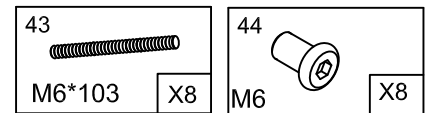

1W

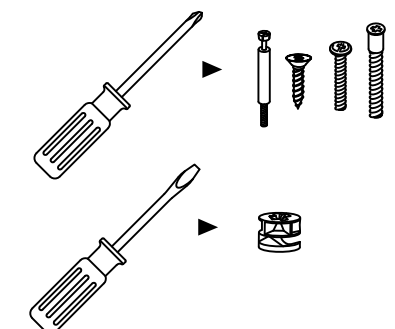
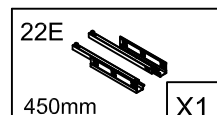

GB

Safety Advice and Warnings

IMPORTANT! KEEP FOR FUTURE REFERENCE: Read Carefully.

- The bottom mattress base position is the safest. You should always use the cot in the lowest position as soon as your baby is old enough to sit up.
- **WARNING:** Do not leave anything in the cot or place the cot close to another product, which could provide a foothold or present a danger of suffocation or strangulation, e.g. strings, blind/curtain cords etc.
- **WARNING:** Do not use the cot/bed if any part is broken, torn or missing.
- Use only spare parts approved by BabyStyle.
- When choosing a mattress, ensure that the height between the surface of the mattress to the upper edge of the bed frame is at least 500mm in the lowest position and at least 200mm in the highest position of the bed base.
- There should never be a gap of more than 30mm between the mattress and the sides or the ends of the cot.
- Regularly check that nuts bolts& fittings are tightened properly. Loose fittings should be retightened as necessary. Loose fittings can result in snagging clothes or cords posing a risk of strangulation.
- This cot bed is intended for use for children from birth to approximately 4 years of age. Use the cot for children from 0 to approx. 18 months; use the toddler bed from approx. 18 months to 4 years.
- **WARNING:** Do not use more than one mattress in the cot.
- Do not use a mattress with a depth greater than 100mm
- We recommend the use of the BabyStyle Dream sprung mattress for this cot (nominal size 1400mm x 700mm x 100).
- **WARNING:** Be aware of the risk of open fire and other sources of strong heat, such as electric bar fires, gas fires etc. in the vicinity of the cot.
- **WARNING:** Do not place this child's bed near heat sources, windows and other furniture
- Clean with a damp cloth. Do not use abrasives or aggressive cleaning products.
- To prevent injury from falls, as soon as the child is able to climb out of this cot, the cot should no longer be used for that child.
- Children are likely to play, bounce jump and climb on beds, therefore the child's bed should not be placed too close to other furniture or windows, and should be either tight to the wall or have a gap of 300mm between the wall and the side of the bed
- **THIS PRODUCT IS GUARANTEED FOR A PERIOD OF 6 MONTHS FROM THE DATE OF PURCHASE AGAINST FAULTY PARTS & WORKMANSHIP. IN THE UNLIKELY EVENT OF THE PRODUCT REQUIRING SERVICE OR REPAIR PLEASE CONTACT THE RETAIL OUTLET FROM WHICH THE PURCHASE WAS ORIGINALLY MADE.**
- THIS PRODUCT HAS BEEN DESIGNED AND MANUFACTURED TO MEET BS EN 716-1/2:2017 & BS 8509:2008 + A1:2011 BabyStyle UK Ltd LE12 7RJAJB1604/16052011: V.1

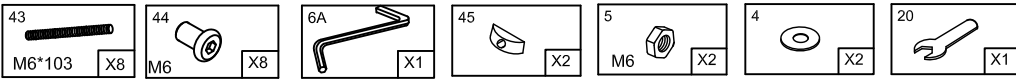

1A
1Q
1T

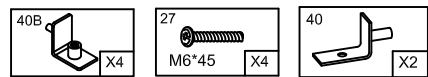
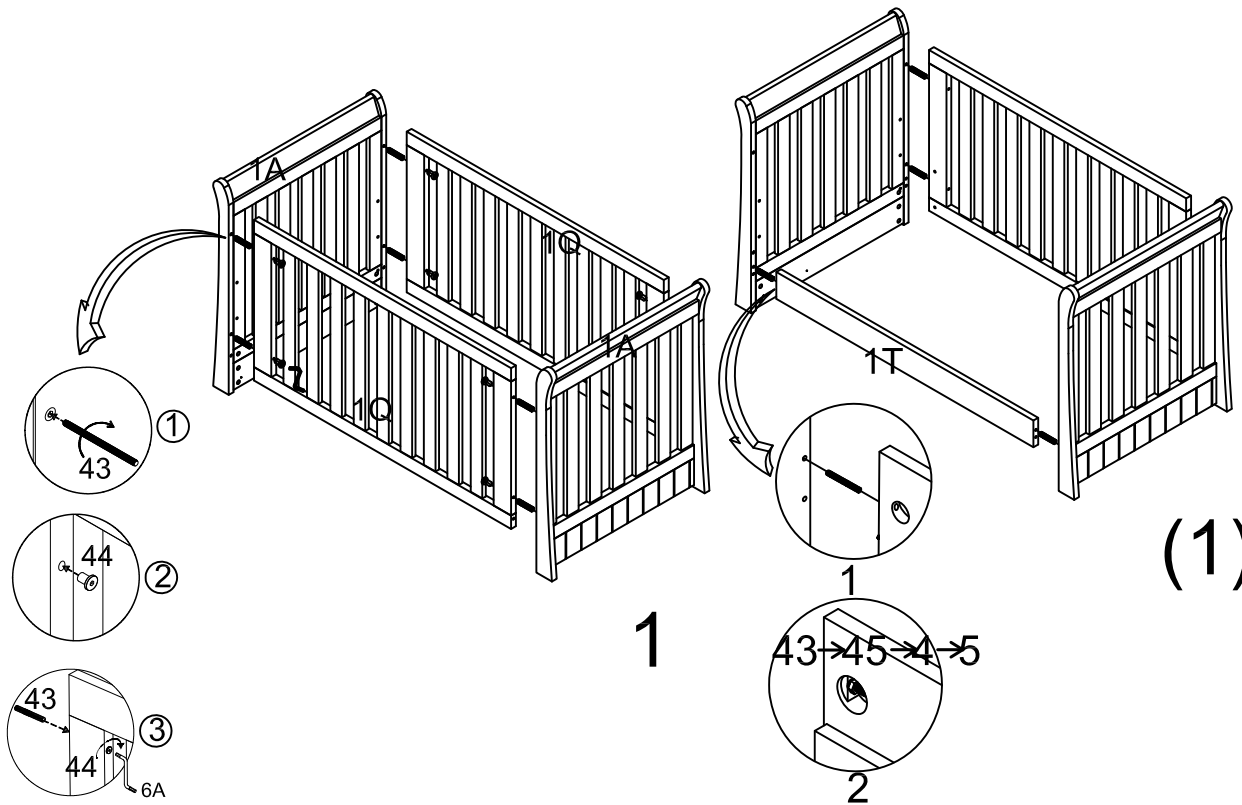

1S
1G
1F
1M

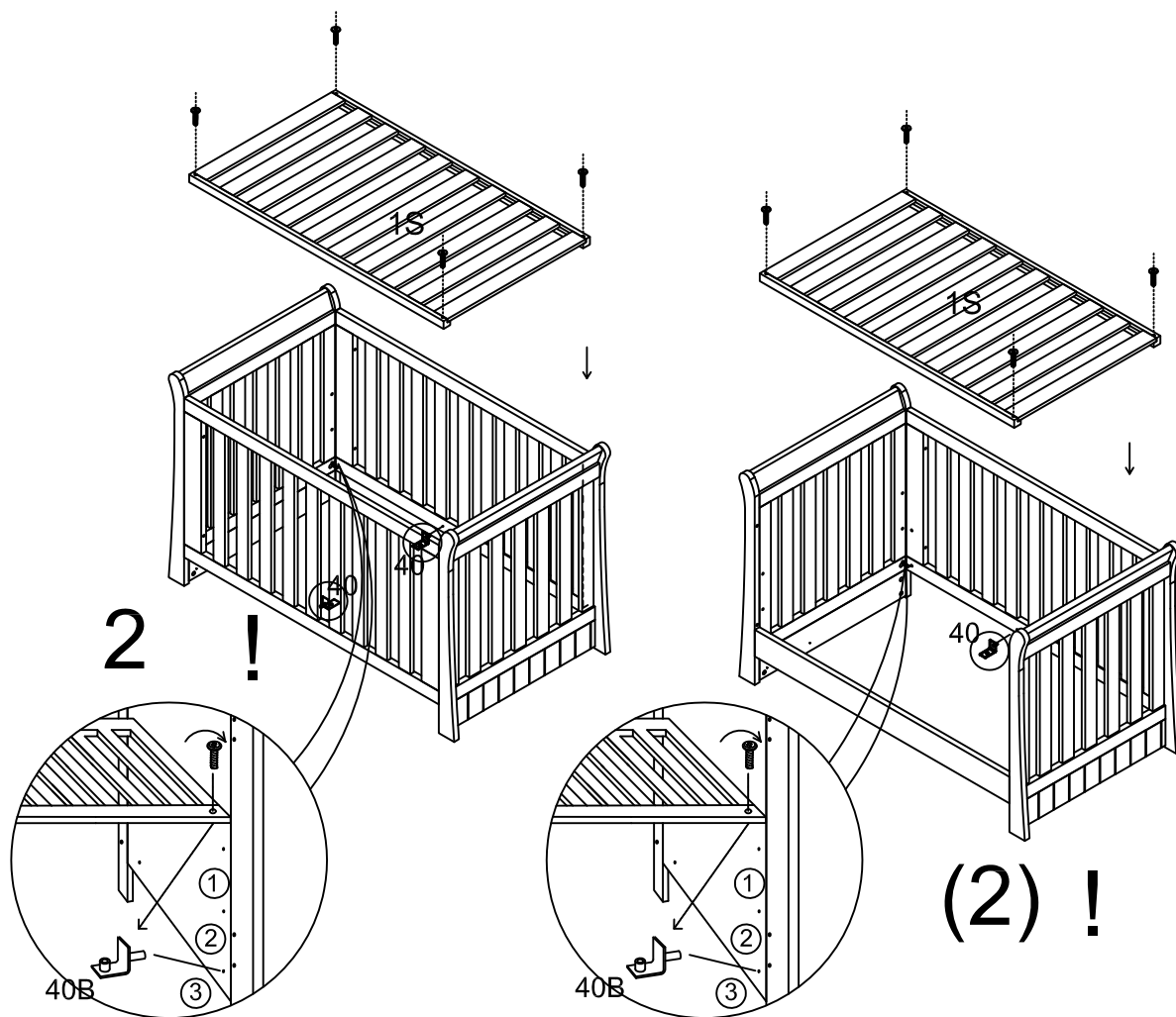

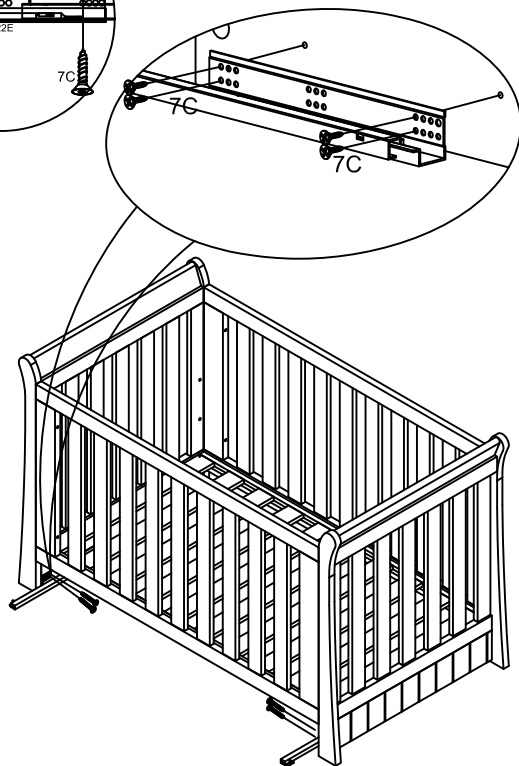
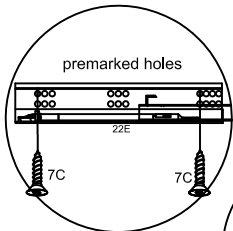
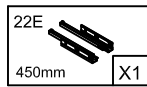
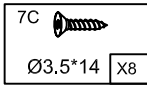
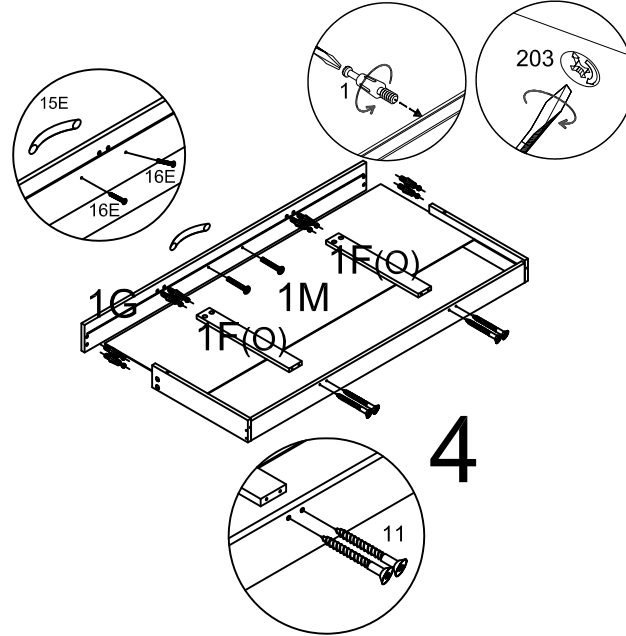
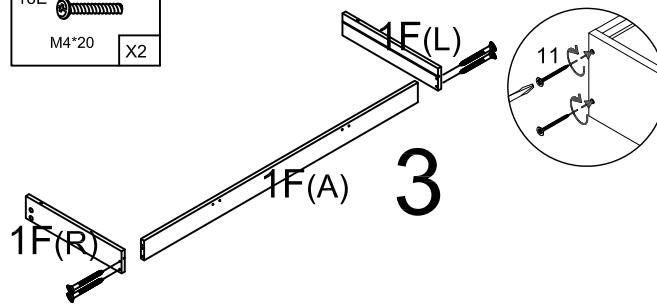
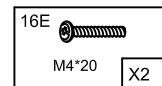
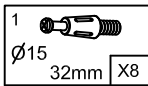
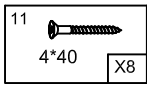

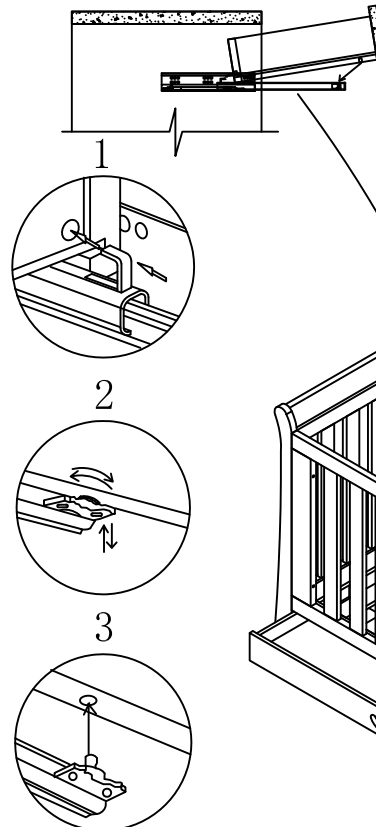

5



6

7C  Ø3,5*14 X8

22E  450mm X1

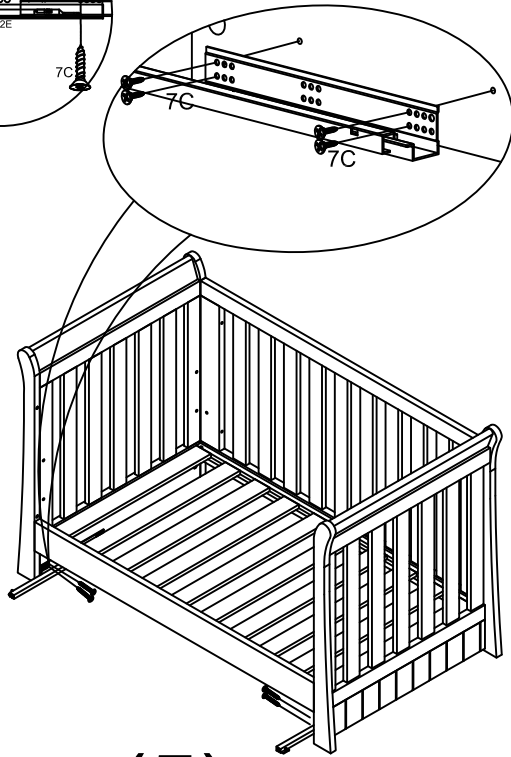
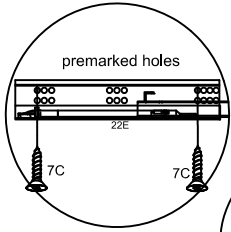

(5)

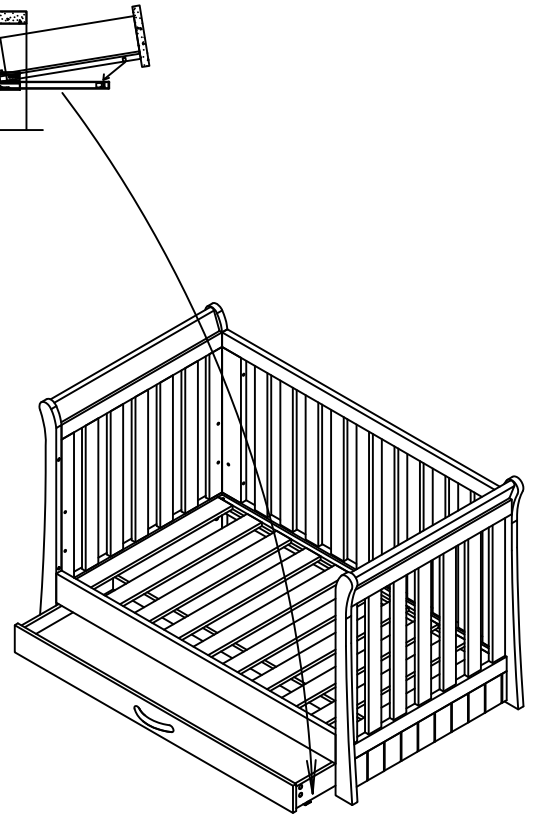
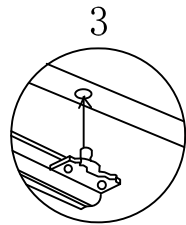
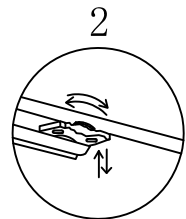
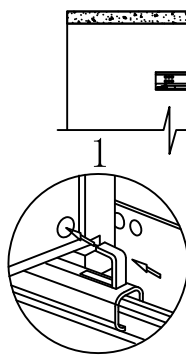

(6)



7



(7)