

# BORDEAUX Playpen Instructions

IMPORTANT, KEEP FOR FUTURE REFERENCE: READ CAREFULLY.

20 min.

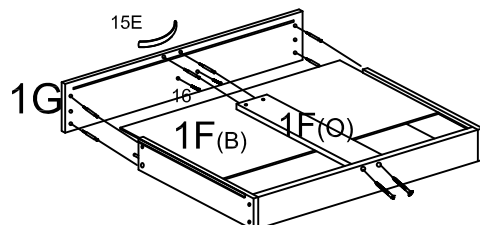
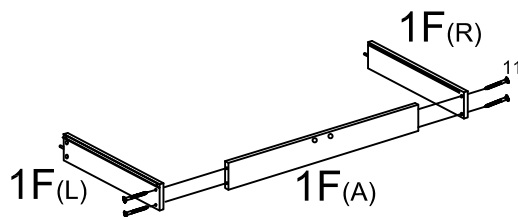
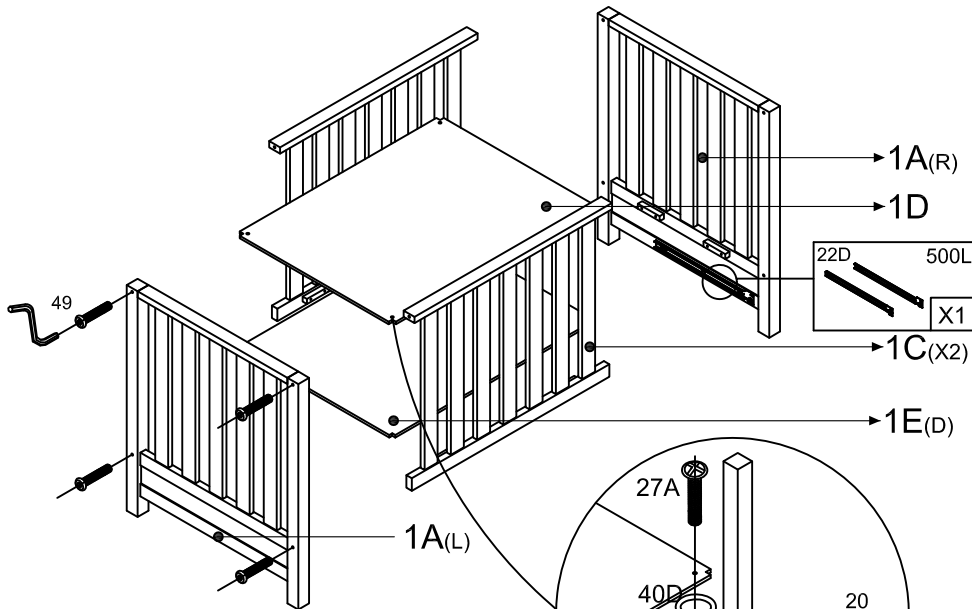
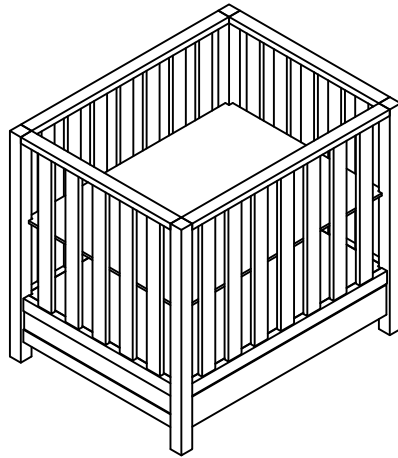
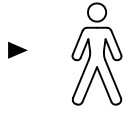

**BDX PP1118:** 1A

**BDX PP1218:** 1C

**BDX PP1318:** 1D,1E,1F,1G,1H

## 1H

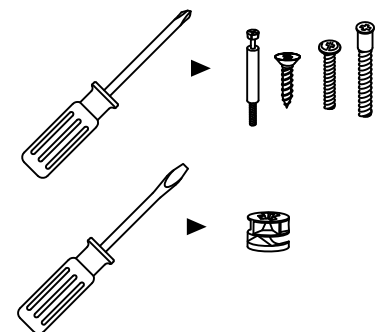
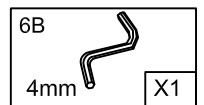
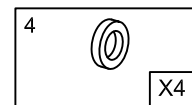
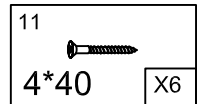
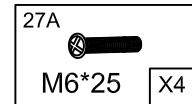
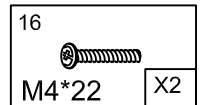
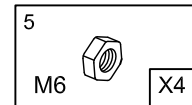
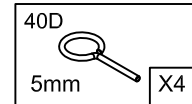
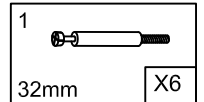
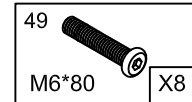

# GB

## Safety Advice and Warnings

### IMPORTANT! KEEP FOR FUTURE REFERENCE: Read Carefully.

- **WARNING:** Do not place the playpen close to an open fire or other heat source. Be aware of the risk of open fire and other sources of strong heat, such as electric bar open fire, gas fires, etc. in the near vicinity of the cot.
- **WARNING:** Do not use the playpen without the base.
- Maximum age of child for which the playpen is intended is 24 months.
- The base should always be used in the lowest position as soon as the child is old enough to sit, kneel or to pull itself up.
- **WARNING:** Do not leave anything in the cot or place the cot close to another product, which could provide a foothold or present a danger of suffocation or strangulation, e.g. strings, blind/curtain cords etc.
- All assembly fittings should always be tightened properly;
- Do not use the playpen if any part is broken, torn or missing and use only spare parts approved by manufacturer.
- Accessories which are not approved by the manufacturer shall not be used.
- Clean with a damp cloth. Do not use abrasives or aggressive cleaning products.
- **Warning:** Never leave your child unsupervised.
- The lowest base position is the safest. You should always use the cot in the lowest position as soon as your baby is old enough to sit up.
- When the child is able to climb out of the cot, to prevent injury from falling, the cot shall no longer be used for that child.
- Please make sure that the mattress fits perfectly. The distance between the top of the cot side and the top of the mattress should be at least 500 mm in lowest position and at least 200 mm in highest position. The thickness of mattress must not exceed 120mm. Please keep this in mind when you buy the mattress, the thickness should be matched to these dimensions.
- Recommended dimensions for the mattress: l x w x h = 93 cm x 71 cm x 11 cm, and minimum dimensions of the mattress: l x w = 90 cm x 68 cm. Gap between the mattress and the sides and ends must not exceed 30 mm.
- **WARNING:** Do not use more than one mattress.
- THIS PRODUCT HAS BEEN DESIGNED AND MANUFACTURED TO MEET BS EN 12227: 2010 & BS EN 716-1/2: 2008.  
BabyStyle UK Ltd LE12 7RJ. AJB1210/13052012: V.1